

REMOTE CONTROL MANUAL

Universal



Suitable For Models:

CRE-071AS
CRE-100AS
CRE-125AS
CRE-140AS
WRE-026AS
WRE-035AS
WRE-050AS
WRE-071AS
WRE-080AS
MRE-035AS
MRE-050AS

IMPORTANT NOTE:

Please read this manual carefully before operating your new remote control and keep it near the unit for future reference.

That's better. That's Actron.



ActronAir

Table of Contents

Remote Control Manual

1	General Information	03
2	Function Buttons	05
3	LCD Indicator	07
4	System Operation	08
5	Timer Setup and Operation	09

REMOTE CONTROLLER SPECIFICATIONS

Model	RC-01
Rated Voltage	3.0V (Dry batteries 1.5V AAA x 2)
Signal Receiving Range	8m
Environment	-5°C~60°C

This manual is a controlled document which contains confidential and proprietary information. Distribution, modification, copying and/or reproduction are prohibited without written consent from ActronAir

Product design and specifications are subject to change without prior notice for product improvement.

Location of the remote controller

- Use the remote controller within a distance of 8 metres from the appliance, pointing it towards the receiver. Reception is confirmed by a beep.

! CAUTIONS

- The air conditioner will not receive the command if curtains, doors or other materials block the signals from the remote controller to the indoor unit.
- Prevent any liquid from falling into the remote controller. Do not expose the remote controller to direct sunlight or heat.
- If the infrared signal receiver on the indoor unit is exposed to direct sunlight, the air conditioner may not function properly.
- If other electrical appliances react to the remote controller, either move these appliances or consult your installer.
- Do not drop the remote controller. Handle with care.
- Do not place heavy objects on the remote controller, or step on it.

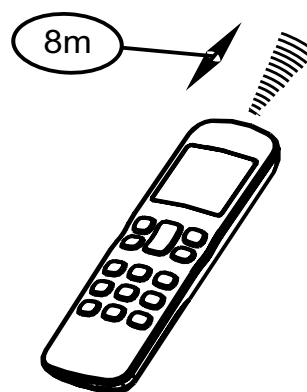
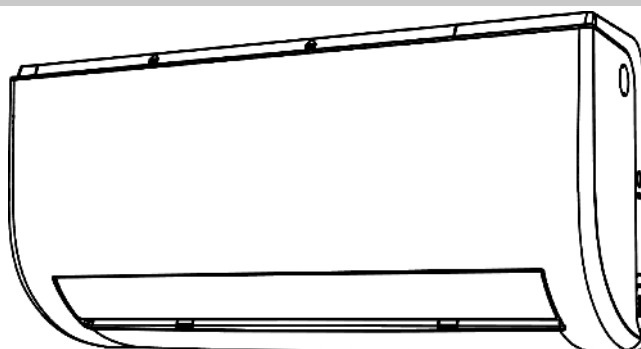

Using the remote controller holder

- The remote controller can be attached to a wall or a pillar by using the remote controller holder.
- Before installing the remote controller, check that the air conditioner receives the signals properly.
- Install the remote controller with two screws.
- For installing or removing the remote controller, move it up or down in the holder.

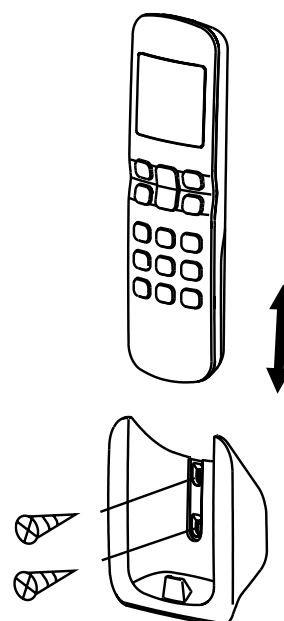

Replacing Batteries

The following cases are indications of a low or dead batteries, if encountered please replace old batteries with new ones.

- Beep sound is not emitted when a signal is transmitted.
- LCD Indicator fades away.

The remote controller is powered by two 1.5V AAA batteries housed in the back of the remote controller and protected by a cover.

- (1) Remove the cover in the rear part of the remote controller.
- (2) Remove the old batteries and insert the new batteries, placing the (+) and (-) ends correctly.
- (3) Install the cover back on.

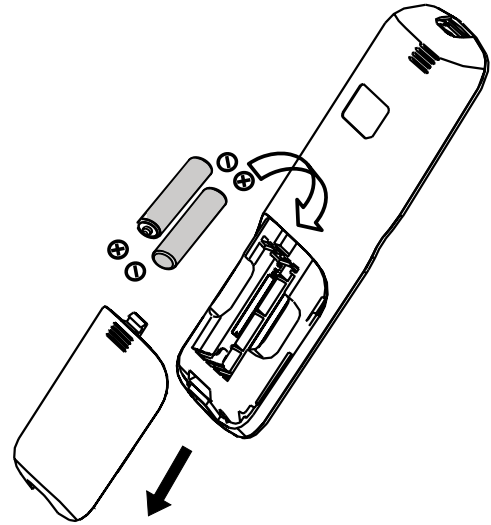

! CAUTIONS

When the batteries are removed, the remote controller erased all settings. After inserting new batteries, remote controller and the A/C unit may have a different settings. To sync their settings, press any button or adjust the settings from remote controller. The A/C unit will follow the new remote controller settings.

! CAUTIONS

- Do not mix old and new batteries or batteries of different types
- Do not leave the batteries in the remote controller if
- Do not use rechargeable batteries.

Overview

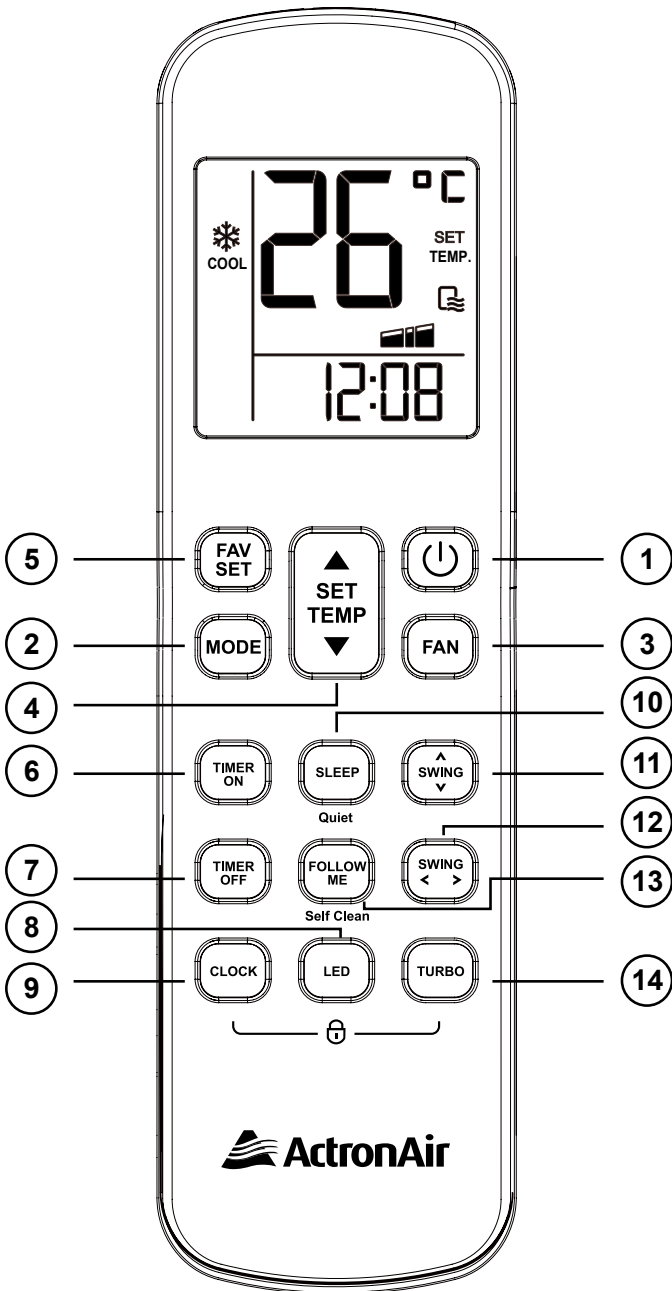

1. ON/OFF

This button turns the air conditioner ON or OFF.

2. MODE

Press this button to modify the air conditioner mode in a sequence of following:

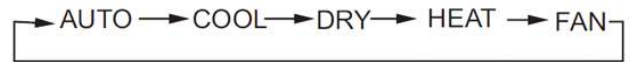

3. FAN

Used to select the fan speed in four steps:



NOTE: You can not switch the fan speed in AUTO or DRY mode.

4. SET TEMP

UP: Press this button to increase the indoor temperature setting in 1°C increments up to 30°C.

DOWN: Press this button to decrease the indoor temperature setting in 1°C increments down to 17°C.

NOTE: Temperature control is not available in Fan mode.

5. FAV SET

Used to store or activate your favourite settings. Hold this button for more than 2 seconds to store your favourite settings. After storing your settings when FAV SET button is pressed the remote controller will adjust the system automatically to your favourite settings.

6. TIMER ON

Press this button to initiate the auto-on timer sequence. Each time you press the button, the time increases by half an hour between 0 and 10 hours and by one hour between 10 and 24 hours.

To cancel the auto-timed program, simply adjust the auto-on timer to 0.0

7. TIMER OFF

Press this button to initiate the auto-off timer sequence. Each time you press the button, the time increases by half an hour between 0 and 10 hours and by one hour between 10 and 24 hours.

To cancel the auto-timed program, simply adjust the auto-off timer to 0.0.

Overview

8. LED

Activate or Disable the indoor unit Display. Press this button to hide the indoor unit display, press it again to illuminate the display.

9. CLOCK

Use to set the time Clock.

NOTE: Press the CLOCK button and TURBO button together to lock or unlock the keyboard.

10. SLEEP/QUIET

Activate or Disable sleep function. Adjusts and maintains the temperature while you sleep and can save energy. This function is not available on DRY mode. For more detail on this function please refer to "Sleep Operation" in your OWNER'S MANUAL.

Hold the button more than 2 seconds to Activate or Disable QUIET mode. When QUIET mode is initiated, the indoor fan speed will reduce to minimum air flow providing a whisper quiet noise.

NOTE: The unit will disable SLEEP mode if MODE, FAN or ON/OFF button are pressed.

11. SWING ↕

Used to stop or start vertical louvre movement and set the desired up/down air flow direction. The vertical louvre changes 6 degrees in angle for each press.

Hold the button for more than 2 seconds to activate the auto vertical swing feature.

12. SWING ↔

Used to stop or start horizontal louvre movement and set the desired left/right air flow direction. The horizontal louvre changes 6 degrees in angle for each press.

Hold the button for more than 2 seconds to activate the auto horizontal swing feature.

13. FOLLOW ME/SELF CLEAN

Press this button to Activate or Disable FOLLOW ME function. When this function is activated, the remote control will sense and display the temperature at its location. The remote control will then send this signal to the air conditioner and continue to do so every 3 minutes. Press the Follow Me button again to disable this function. The air conditioner will cancel the Follow Me function automatically if it doesn't receive the signal for a period of 7 minutes.

Hold the button more than 2 seconds to Activate or Disable SELF CLEAN function. Under SELF CLEAN function, the air conditioner will automatically clean and dry the Evaporator and keep it fresh for the next operation. During this operation the indoor screen will display "SC".

14. TURBO

Press this button to Activate or Disable TURBO function. Turbo function enables the unit to reach the preset temperature during cooling or heating operation faster.

NOTE







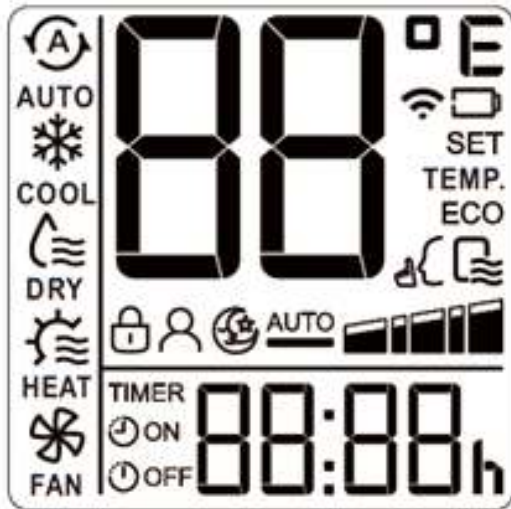



This remote controller is Universal and can be used with many different systems. All the functions described are accomplished by the system, if the system does not have the feature pressing the button on the remote controller will have no corresponding operation.

LCD indicators





Information is displayed when the remote controller is powered up.



 **AUTO**  **COOL**  **DRY**  **HEAT**  **FAN**

-  **Displayed when data transmitted.**
-  **Set temperature or show room temperature.**
-  **Description of low battery detection**
 - The low-battery indicator on the remote control will continue to blink when the batteries are low, it may reduce the transmission distance of the remote control and the display becomes blurred.
 - Replace with new batteries immediately. The low battery indicator will disappear after the batteries are replaced.
-  **Displayed when remote controller is ON.**
-  **Displayed when QUIET Mode is activated**
-  **ON** **Displayed when TIMER ON time is set.**
-  **OFF** **Displayed when TIMER OFF time is set.**
-  **CLOCK time (set hours and minutes)**
-  **Displayed in Sleep Mode operation.**
-  **Indicated that the air conditioner is operating in Follow me Mode.**
-  **Displayed when lock function is activated.**

Fan speed indication

-  **AUTO** Auto fan speed
-  Low speed
-  Medium speed
-  High speed

NOTE

All indicators shown in the figure are for the purpose of clear presentation. But during the actual operation only the relative functional signs are shown on the display window.

Auto Operation

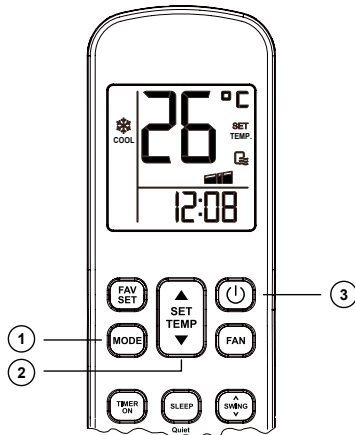

1. Press the **MODE** button to select Auto.
2. Press the **UP/DOWN** button to set the desired temperature. The temperature can be set within a range of 17°C~ 30°C in 1°C increments.
3. Press the **ON/OFF** button to start the air conditioner.

NOTE

1. In the Auto mode, the air conditioner can logically choose the mode of Cooling, Fan, and Heating by sensing the difference between the actual ambient room temperature and the setting temperature on the remote controller.
2. In the Auto mode, you can not adjust the fan speed. It has already been automatically controlled.
3. If the Auto mode is not comfortable for you, the desired mode can be selected manually.

Cooling / Heating / Fan Operation

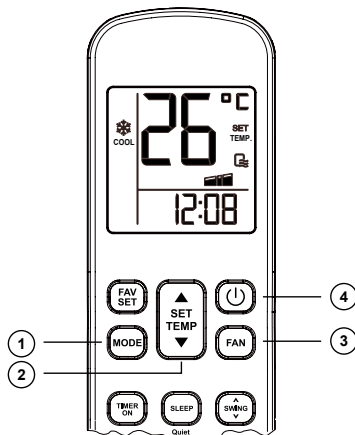

1. Press the **MODE** button to select COOL, HEAT or FAN mode.
2. Press the **UP/DOWN** buttons to set the desired temperature. The temperature can be set within a range of 17°C~ 30°C in 1°C increments.
3. Press the **FAN** button to select the fan speed in four steps - Auto, Low, Med or High.
4. Press the **ON/OFF** button to start the air conditioner.

NOTE

In the FAN mode, the room temperature is not controlled and the set temperature will not be displayed on the remote controller. In this case, only step 1, 3 and 4 may be performed.

Dehumidifying Operation (Dry Mode)

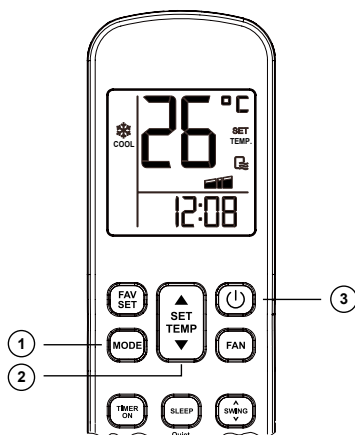

1. Press the **MODE** button to select DRY mode.
2. Press the **UP/DOWN** buttons to set the desired temperature. The temperature can be set within a range of 17°C~ 30°C in 1°C increments.
3. Press the **ON/OFF** button to start the air conditioner.

NOTE

In the Dehumidifying (dry mode), you can not adjust the fan speed, as it will be automatically controlled.

Clock Setting and Timer Operation

Set the clock

Before you start operating the air conditioner, set the clock of the remote controller using the procedures given in this section. The clock panel on the remote controller will display the time regardless of whether the air conditioner is in use or not.

Initial Setting of the Clock

After batteries are inserted in the remote controller, hold down the CLOCK button for 3 seconds, the clock panel will display "12:00" and begin to flash.

1. TIME adjust button

Use the SET TEMP up and down buttons to set the time. Each time you press the button, the time moves forward or backward by one minute depending on which side you press. The time adjusts as quickly as you press the button.

Hold the button to adjust the time forward or backward by 10 minutes depending on which side you press down.

2. CLOCK button

When the right time is achieved, press the CLOCK button or wait for 3 seconds, the clock time stops flashing and the clock starts operating.

3. Readjusting the Clock

Press the CLOCK button on the remote controller for about 3 seconds, the time in the clock display will start to flash. To set the new time, follow 1 and 2 of "Initial Setting of the Clock".

CAUTION

When you select the timer operation, the remote controller automatically transmits the timer signal to the indoor unit for the specified time. Therefore, keep the remote controller in a location where it can transmit the signal to the indoor unit properly.

The effective operation time set by the remote controller or the timer function is limited to the following settings: 0.5, 1.0, 1.5, 2.0, 2.5, 3.0, 3.5, 4.0, 4.5, 5.0, 5.5, 6.0, 6.5, 7.0, 7.5, 8.0, 8.5, 9.0, 9.5, 10, 11, 12, 13, 14, 15, 16, 17, 18, 19, 20, 21, 22, 23 and 24.

Timer operation

Press the TIMER ON button to set the auto-on timer of the unit. Press the TIMER OFF button to set the auto-off timer of the unit.

To set the Auto-on time.

1. Press the TIMER ON button. The remote controller will display Timer on () ON), the last Auto-on setting time and the signal "h" will be shown on the LCD display area of your indoor unit. Now it is ready to reset the Auto-on time to START the operation.
2. Press the TIMER ON button again to set desired Auto-on time. Each time you press the button, the time increases by half an hour between 0 and 10 hours and by one hour between 10 and 24 hours.
3. After setting the TIMER ON, there will be a one second delay before the remote controller transmits the signal to the air conditioner. Then, after approximately another one second, the signal "h" will disappear and the clock time will re-appear on the LCD display area of your indoor unit.
4. To cancel the auto-timed program, simply adjust the auto-on timer to 0.0.

To set the Auto-off time.

1. Press the TIMER OFF button. The remote controller will display Timer on () OFF), the last Auto-off setting time and the signal "h" will be shown on the LCD display area of your indoor unit. Now it is ready to reset the Auto-off time to START the operation.
2. Press the TIMER OFF button again to set desired Auto-off time. Each time you press the button, the time increases by half an hour between 0 and 10 hours and by one hour between 10 and 24 hours.
3. After setting the TIMER OFF, there will be a one second delay before the remote controller transmits the signal to the air conditioner. Then, after approximately another one second, the signal "h" will disappear and the clock time will re-appear on the LCD display area of your indoor unit.
4. To cancel the auto-timed program, simply adjust the auto-off timer to 0.0.

Example of Timer setting

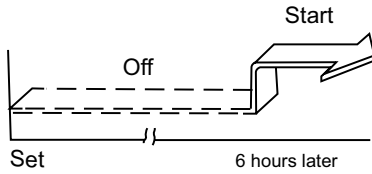

TIMER ON (Auto-on Operation)

The TIMER ON feature is useful when you want the unit to turn on automatically at a desired time.

Example:

To start the air conditioner in 6 hours.

1. Press the TIMER ON button, the last setting of starting operation time and the signal "h" will show on the display area.
2. Press the TIMER ON button to display "6.0 h" on the TIMER ON display of the remote controller.
3. Wait for 2 second and the digital display area will show the clock time again. The "TIMER ON (🕒ON)" indicator remains on and this function is activated.

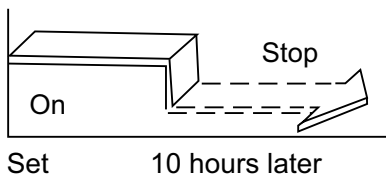

TIMER OFF (Auto-off Operation)

The TIMER OFF feature is useful when you want the unit to turn off automatically at a desired time.

Example:

To stop the air conditioner in 10 hours.

1. Press the TIMER OFF button, the last setting of stopping operation time and the signal "h" will show on the display area.
2. Press the TIMER OFF button to display "10 h" on the TIMER OFF display of the remote controller.
3. Wait for 2 seconds and the digital display area will show the clock time again. The "TIMER OFF (🕒OFF)" indicator remains on and this function is activated.

Example of Timer setting

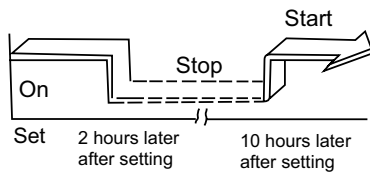

COMBINED TIMER

(Setting both ON and OFF timers simultaneously)

TIMER OFF / TIMER ON (On Stop-Start operation)

This feature is useful when you want to stop the air conditioner after you go to bed, and start it again in the morning when you wake up or when you return home.

Example:

To stop the air conditioner 2 hours after setting, and start it again 10 hours after setting.

1. Press the TIMER OFF button.
2. Press the TIMER OFF button again to display 2.0 h on the TIMER OFF display.
3. Press the TIMER ON button.
4. Press the TIMER ON button again to display 10 h on the TIMER ON display.
5. Wait for 2 seconds and the digital display area will show the clock time again. The "TIMER ON & TIMER OFF" indicator remains on and this function is activated.

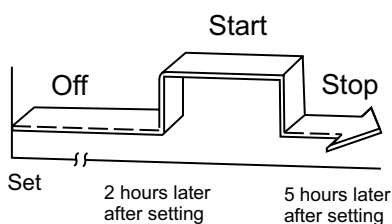
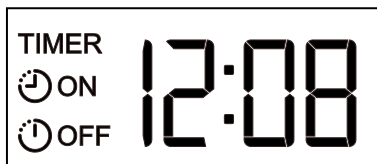

TIMER ON / TIMER OFF (Off Start - Stop operation)

This feature is useful when you want to start the air conditioner before you wake up and stop it after you leave the house.

Example:

To start the air conditioner 2 hours after setting, and stop it 5 hours after setting.

1. Press the TIMER ON button.
2. Press the TIMER ON button again to display 2.0h on the TIMER ON display.
3. Press the TIMER OFF button.
4. Press the TIMER OFF button again to display 5.0h on the TIMER OFF display.
5. Wait for 2 seconds and the digital display area will show the clock time again. The "TIMER ON & TIMER OFF" indicator remains on and this function is activated.



ActronAir

That's better. That's Actron.

actronair.com.au

1300 522 722