

# INSTALLATION AND OWNER'S MANUAL

Universal Wired Remote Controller



Model Number:  
WC-03

**IMPORTANT NOTE:**

Please read this manual carefully before installing or operating your wired remote controller. Make sure to save this manual for future reference.



## Table of Contents

<b>01. Safety Precautions</b> .....	<b>3</b>
<b>02. Installation Accessory</b> .....	<b>6</b>
<b>03. Installation Method</b> .....	<b>6</b>
<b>04. Specification</b> .....	<b>12</b>
<b>05. Feature and Function of the Wired Controller</b> .....	<b>12</b>
<b>06. Name on the LCD of the Wired Controller</b> .....	<b>13</b>
<b>07. Wired Controller Buttons</b> .....	<b>13</b>
<b>08. Preparatory Operation</b> .....	<b>14</b>
<b>09. Operation</b> .....	<b>14</b>
<b>10. Time Functions</b> .....	<b>17</b>
<b>11. Weekly Timer 1</b> .....	<b>18</b>
<b>12. Weekly Timer 2</b> .....	<b>21</b>
<b>13. Fault Alarm Handling</b> .....	<b>24</b>
<b>14. Technical Indication and Requirement</b> .....	<b>24</b>
<b>15. Queries and Settings</b> .....	<b>24</b>
<b>16. Download and Install the Easyconnect App</b> .....	<b>26</b>
<b>17. Device Configuration</b> .....	<b>26</b>
17.01. Amazon Alexa .....	26
17.02. Google Home .....	28
17.03. Smart Device (Easyconnect) .....	29

## 01. Safety Precautions

- This manual gives detailed description of the precautions that should be brought to your attention during operation.
- To ensure the correct service of the wired controller please read this manual carefully before using the unit.
- For convenience of future reference, keep this manual after reading it.
- All the pictures in this manual are for explanation purpose only. There may be slightly different from the wired remote controller you purchased (depend on model). The actual shape shall prevail.

### WARNINGS FOR PRODUCT USE

- **DO NOT** install the unit in a place vulnerable to leakage of flammable gases. If flammable gases leak or linger around the wired controller, fire may occur.
- **CODES, REGULATIONS, AND STANDARDS**  
The installer/contractor assumes responsibility to ensure that the installation complies with the relevant council, state/federal codes, regulations and building code standards. All electrical wiring must be in accordance with current electrical authority regulations and all wiring connections to be as per the electrical diagram/s provided with the unit.

FOR COMPLIANCE WITH QUEENSLAND  
ELECTRICAL SAFETY REGULATIONS 2002  
This refers to electrical works only



**MUST BE INSTALLED BY A LICENSED  
ELECTRICIAN**

### Read Safety Precautions Before Installation

Thank you for purchasing this air conditioner. This manual will provide you with information on how to operate, maintain, and troubleshoot your air conditioner. Following the instructions will ensure the proper function and extended lifespan of your unit.

Please pay attention to the following signs:



**WARNING**

Failure to observe a warning may result in death or serious injury. The appliance must be installed in accordance with national regulations.



**CAUTION**

Failure to observe a caution may result in injury or equipment damage.

This manual is a controlled document which contains confidential and proprietary information.

Distribution, modification, copying and/or reproduction are prohibited without written consent from ActronAir

Product design and specifications are subject to change without prior notice for product improvement.

 **WARNING**

- Carefully read the Safety Precautions before installation.
- Adhere to this installation manual.
- Ensure installation is performed by qualified technician only.
- Improper installation by unqualified individuals may result in faulty installation, electric shock, or fire hazard.
- Improper installation may lead to electric shock or fire.
- Only trained and qualified HVAC technicians should install, repair and service this air conditioning unit, strictly follow the installation instructions set forth in this manual.
- Reinstallation must be performed by a qualified service technician.

Do not uninstall the unit without proper authorisation.

Disconnection while power on may lead to abnormal operation, heating or re of the air condition.

**NOTE**

- Do not install the unit in a place vulnerable to leakage of flammable gases. If flammable gases leak near the controller, fire may occur.
- Do not operate with wet hands or let water enter the controller. Otherwise, electric shock may occur.

**NOTE**

The specified cables shall be applied in the wiring. No external force should be applied to the terminal to prevent wire damage and potential fire hazards.



**BATTERY WARNING**



**WARNING:** Contains coin battery.



**WARNING**

**INGESTION HAZARD:** This product contains a button cell or coin battery.



**WARNING**



- **INGESTION HAZARD:** This product contains a button cell or coin battery.
- **DEATH** or serious injury can occur if ingested.
- A swallowed button cell or coin battery can cause Internal Chemical Burns in as little as **2 hours**.
- **KEEP** new and used batteries **OUT OF REACH of CHILDREN**.
- **Seek immediate medical attention if a battery** is suspected to be swallowed or inserted inside any part of the body.



**! WARNING**

- Remove and immediately recycle or dispose of used batteries according to local regulations and keep away from children.
- Do NOT dispose of batteries in household trash or incinerate.
- Even used batteries may cause severe injury or death.
- Call a local poison control center for treatment information.
- Non-rechargeable batteries are not to be recharged.
- Do not force discharge, recharge, disassemble, heat above (-20-70°C) or incinerate. Doing so may result in injury due to venting, leakage or explosion resulting in chemical burns.
- Ensure the batteries are installed correctly according to polarity (+ and -).
- Do not mix old and new batteries, different brands or types of batteries, such as alkaline, carbon-zinc, or rechargeable batteries.
- Remove and immediately recycle or dispose of batteries from equipment not used for an extended period of time according to local regulations.
- Always completely secure the battery compartment. If the battery compartment does not close securely, stop using the product, remove the batteries, and keep them away from children.
- If you think batteries might have been swallowed or placed inside any part of the body, seek immediate medical attention.
- Battery type: CR2032
- Battery nominal voltage: 3.0 V

- **WARNING:** The battery is hazardous and **KEEP OUT OF REACH OF CHILDREN** (Whether the battery is new or used).
- For appliances which contain coin or lithium batteries:

 <b>BATTERY WARNING</b>	
<p><b>KEEP OUT OF REACH OF CHILDREN.</b> Swallowing can lead to chemical burns, perforation of soft tissue, and death. Severe burns can occur within 2 hours of ingestion. Seek medical attention immediately.</p>	

- For appliances which contain button or non-lithium batteries.
  - The battery can cause serious injuries if it is swallowed or placed inside any part of the body.
  - If you think batteries might have been swallowed or placed inside any part of the body, seek immediate medical attention.

**Battery Performance**

For more durable batteries, it is recommended to turn off the power when not in use for a period of time.

**! Battery Disposal**

- Do not dispose of batteries as unsorted municipal waste. Refer to local laws for proper disposal of batteries.
- Batteries may have a chemical symbol at the bottom of the disposal icon. This chemical symbol means that the battery contains a heavy metal that exceeds a certain concentration.
- An example is Pb: Lead (>0.004%).
- Appliances and used batteries must be treated in a specialized facility for reuse, recycling and recovery. By ensuring correct disposal, you will help avoid possible negative consequences for the environment and human health.

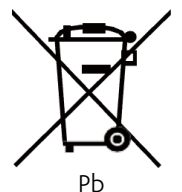

## 02. Installation Accessory

### Select the installation location

Don't install in a place covered with heavy oil, vapor or sulfureted gas, otherwise, this product could become deformed that would lead to system malfunction.

### Preparation before the installation

Please confirm that all the following parts you have been supply.

No.	Name	Qty	Remarks
1	Wired controller	1	-
2	Installation and owner's manual	1	-
3	Screws	3	M3.9 x 25 (For mounting on the wall)
4	Wall plugs	3	For mounting on the wall
5	Screws	2	M4X25 (For mounting on switch box)
6	Plastic screw bars	2	For fixing on switch box
7	Battery	1	CR2032
8	Connecting cables	1	
9	Screws	1	M4X8 (For mounting the connecting cables)

### Precaution of installing the wired controller

1. This manual provides the installation instructions for the wired controller. Please refer to the wiring diagram of this installation manual to connect the wired controller with indoor unit.
2. The wired controller works in a low voltage loop circuit. Do not touch high voltage cables above 115V, 220V, 380V or use them in the circuit; wiring clearance between configured tubes should be at the range of 300-500mm or above.
3. The shielded wire of the wired controller must be firmly grounded.

## 03. Installation Method

### 1. Wired remote controller structural dimensions

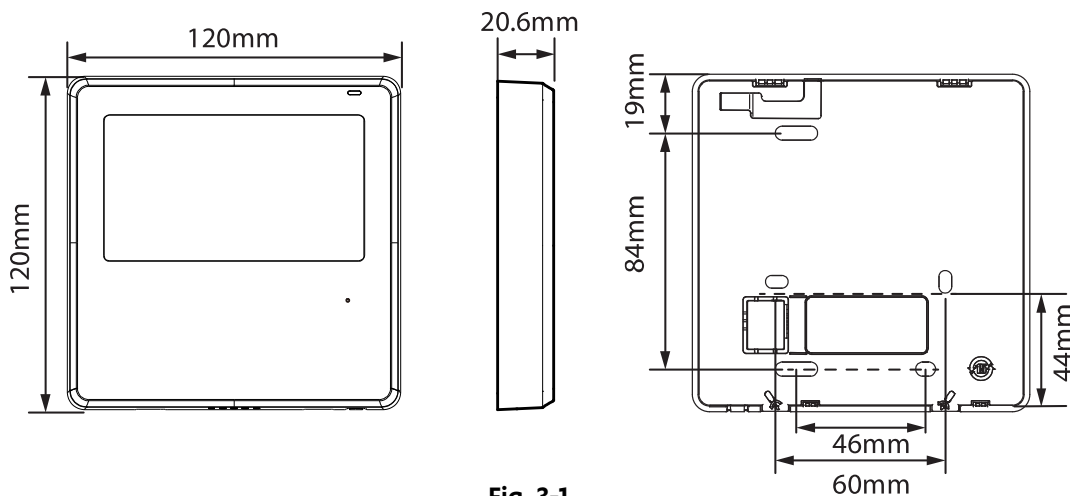

Fig. 3-1

**2. Remove the upper part of the back of the wired controller**

Insert a at head screwdriver into the slots in the lower part of the wired controller (2 places), and remove the upper part of the wired controller.

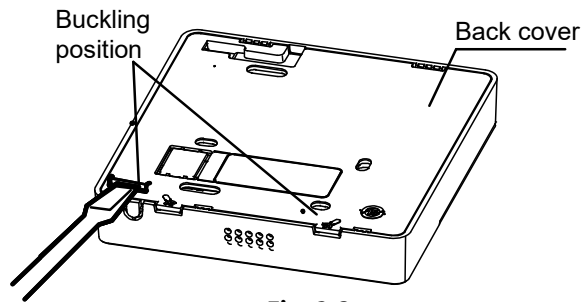

Fig. 3-2

**NOTES**

- Do not pry up and down, only rotate the screwdriver.
- The PCB is mounted in the upper part of the wired controller. Be careful not to damage the board with the screwdriver.

**3. Fasten the back plate of the wired controller**

- For exposed mounting, fasten the back plate on the wall with the 3 screws (ST3.9 x 25) and plugs. (Fig. 3-3)

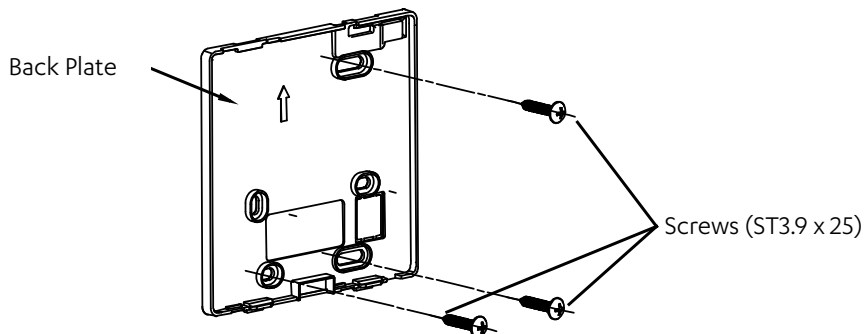
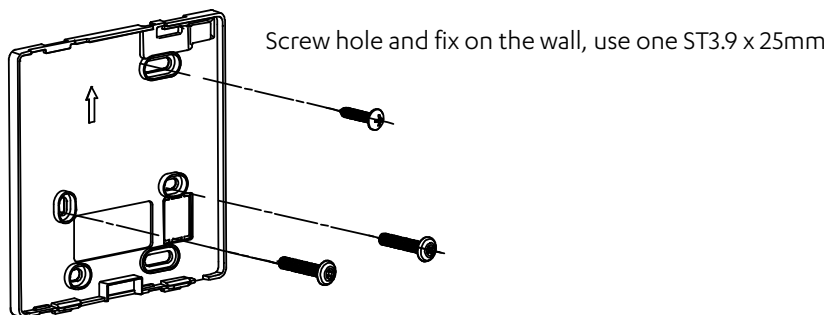

Fig. 3-3

- Use two M4X25 screws to install the back cover and use one ST3.9 x 25 screw to x to the wall.



Screw hole and install on 86 switch box, use two M4 x 25mm

Fig. 3-4

**NOTE**

Put on a flat surface. Be careful not to distort the back plate of the wired controller by overtightening the mounting screws.

4. Wire with the indoor unit

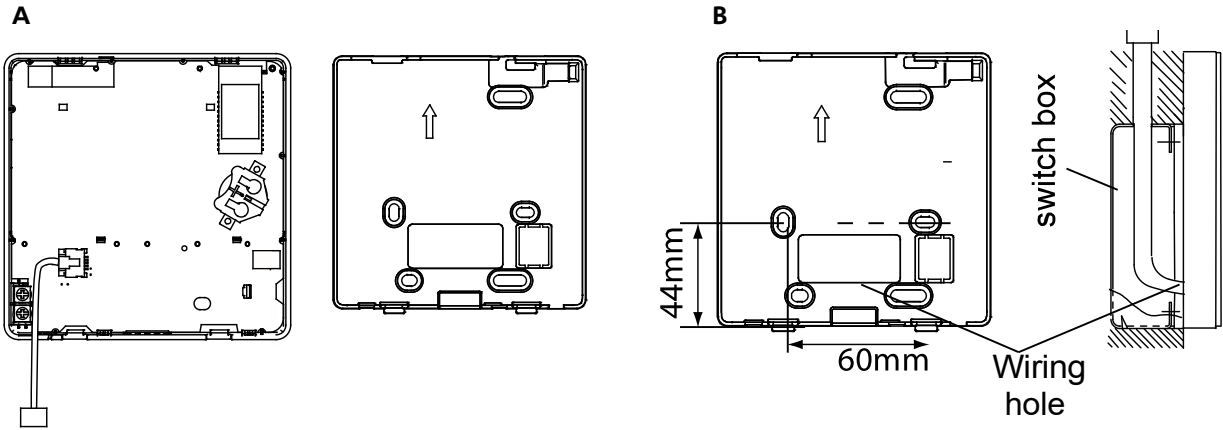

Fig. 3-5

- Connect the wire from the display panel of the indoor unit to a connecting cable. Then connect the other side of the connecting cable to the remote control.

Wiring connection diagram for Cassettes and Ducted

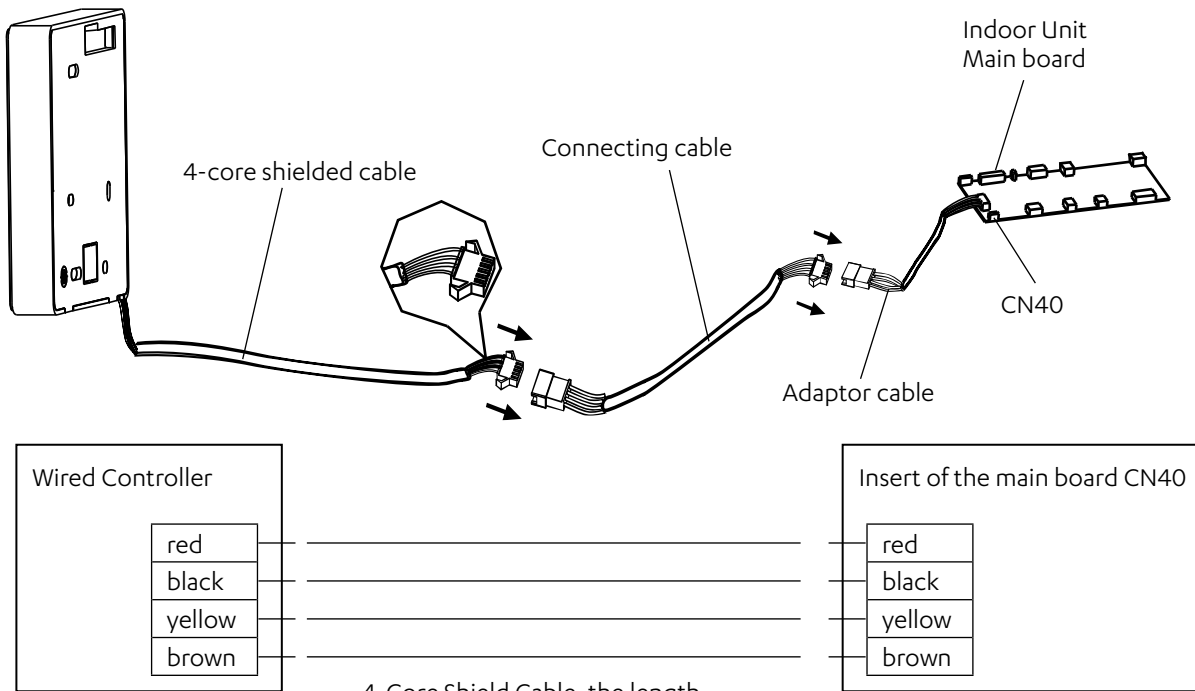

Fig. 3-6

4-Core Shield Cable, the length is decided by installer



Wiring connection diagram for Wall Splits

- Open the front panel , identify the multi function box (See Fig. 3-7).

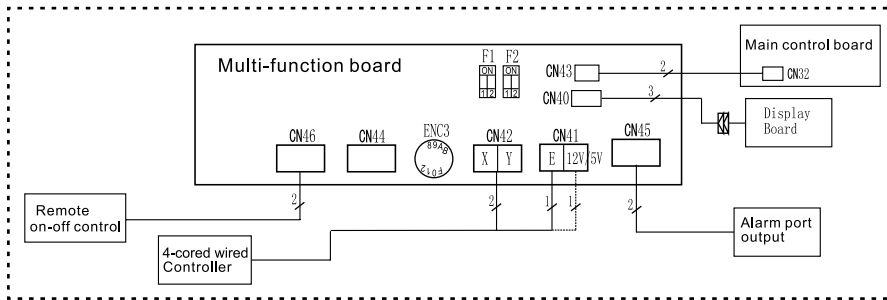

When connecting to 4-core wired controller:

- 12V = Red
- E = Black
- Y = Yellow
- X = Brown

Fig. 3-7

- Cut the terminal of the longer connection cable (See Fig 3-8).
- Connect the four wires to each of the pins in the multi function board as follows: The red wire on wired controller connect to 12V/5V pin on multi function board; black wire to E pin; yellow wire to Y pin; brown wire to X pin. (See Fig. 3-7).

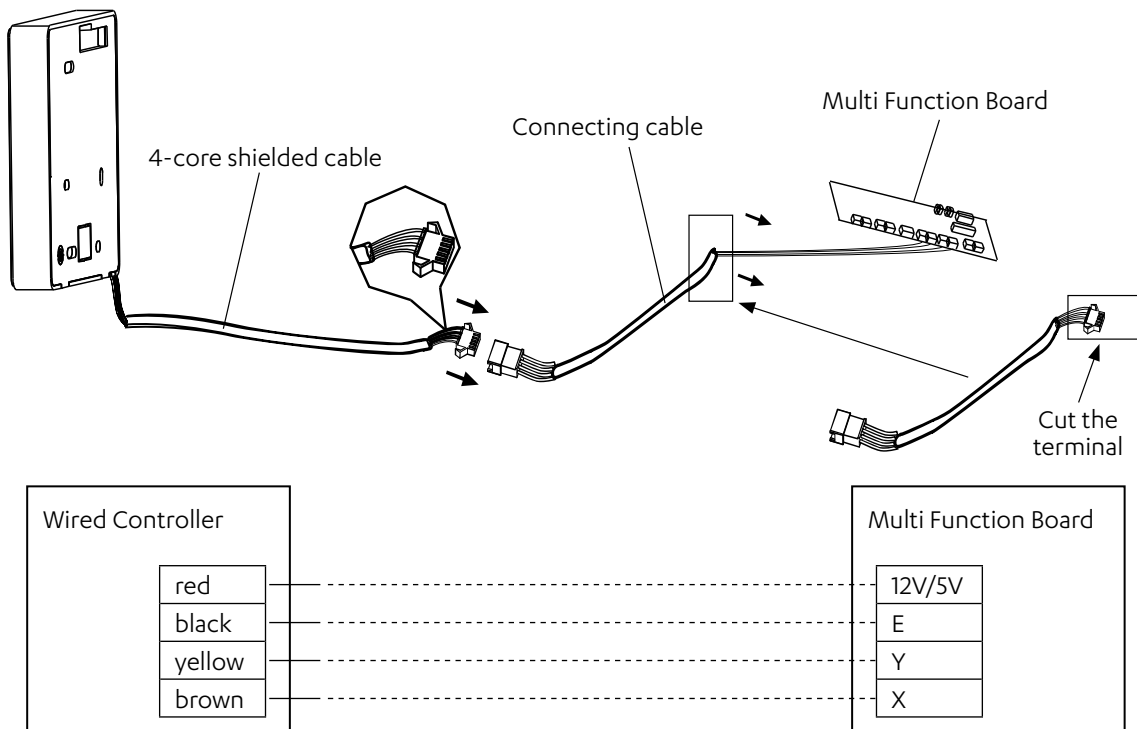

Fig 3-8

5. Battery installation

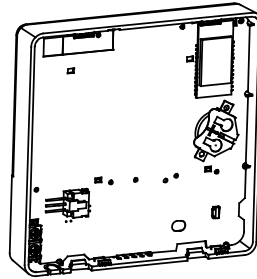

Fig. 3-9

- Please contact professional technical after-sales service if the battery needs to be replaced.
- Put the battery into the installation site and make sure the positive side of the battery is in accordance with the positive side of installation site. (See Fig. 3-9)
- Please make sure to set the correct time during the initial setup. The batteries in the wired controller maintain the time during power failures. If the displayed time is incorrect when power is restored, it indicates that the battery is dead and needs to be replaced.

6. Wiring the indoor unit

There are three methods:

1. From the rear

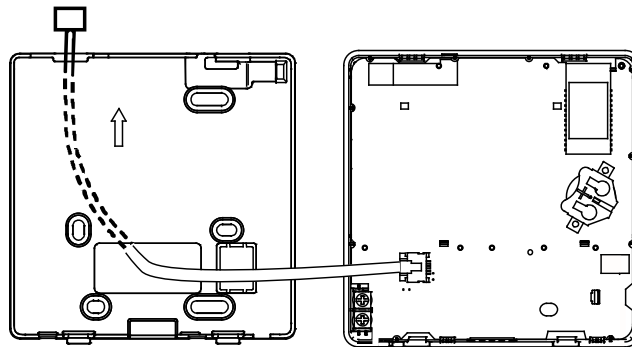

2. From the bottom

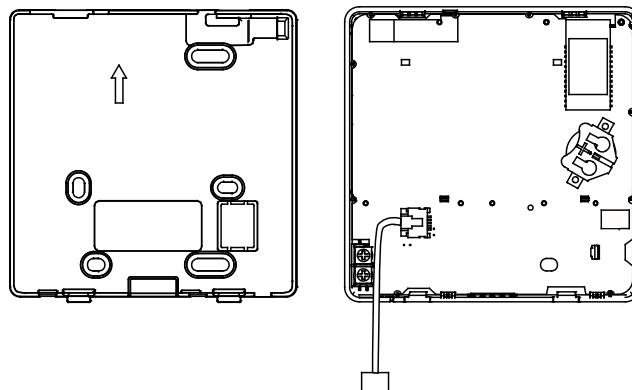

3. From the Top

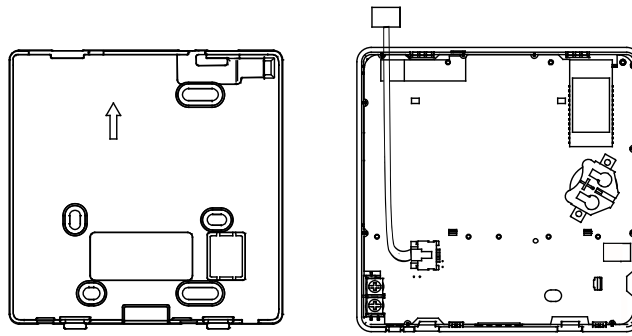

4. Notch the part for the wiring to pass through with a nipper tool.

**NOTE**

DO NOT allow water to enter the remote control. Use a water loop and silicone to seal the wires.

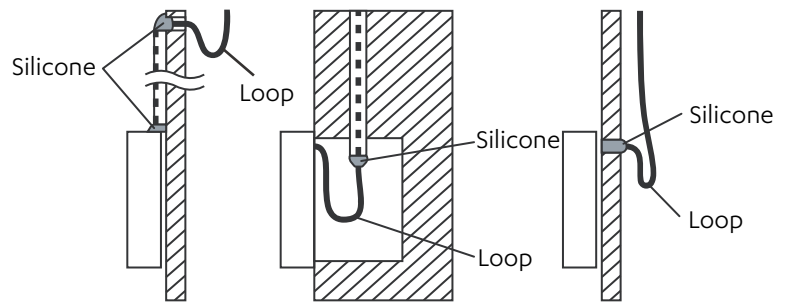

**7. Reattach the upper part of the wired controller**

- After adjusting the upper case and then buckle the upper case; avoid clamping the wiring during installation. (Fig 3-12)

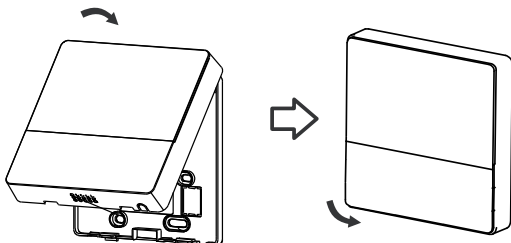

Fig. 3-12

**NOTES**

All the pictures in this manual are for explanation purpose only. Your wired controller may be slightly different. The actual shape shall prevail.

## 04. Specification

<b>Input Voltage</b>	DC 12V
<b>Ambient Temperature</b>	0~43°C
<b>Ambient Humidity</b>	RH40%~RH90%

### Wiring specifications

Wiring Type	Size	Total Length
Shielded PVC or cable	0.75mm <sup>2</sup>	≤ 20m
	1.5mm <sup>2</sup>	≤ 50m

### NOTE

If extension is needed, please purchase the EXT12M.

## 05. Feature and Function of the Wired Controller



### Features:

- LCD display
- Malfunction code display: displays the error code (helpful for service)
- 4-way wire layout design
- Room temperature display
- Weekly Timer

### Functions:

- Mode: Choose Auto-Cool-Dry- Heat -Fan
- Fan speed: Auto/Low/Med/High speed
- Swing (Applicable on Wall Splits and Cassettes)
- Individual louver control (Applicable on Cassettes)
- Timer ON/OFF
- Temp setting
- Weekly timer
- Follow me
- Turbo
- 24-hour System
- 12-hour System
- Auto-restart
- Automatic airflow test
- Rotation and back-up
- Child lock
- LCD display

### 06. Name on the LCD of the Wired Controller

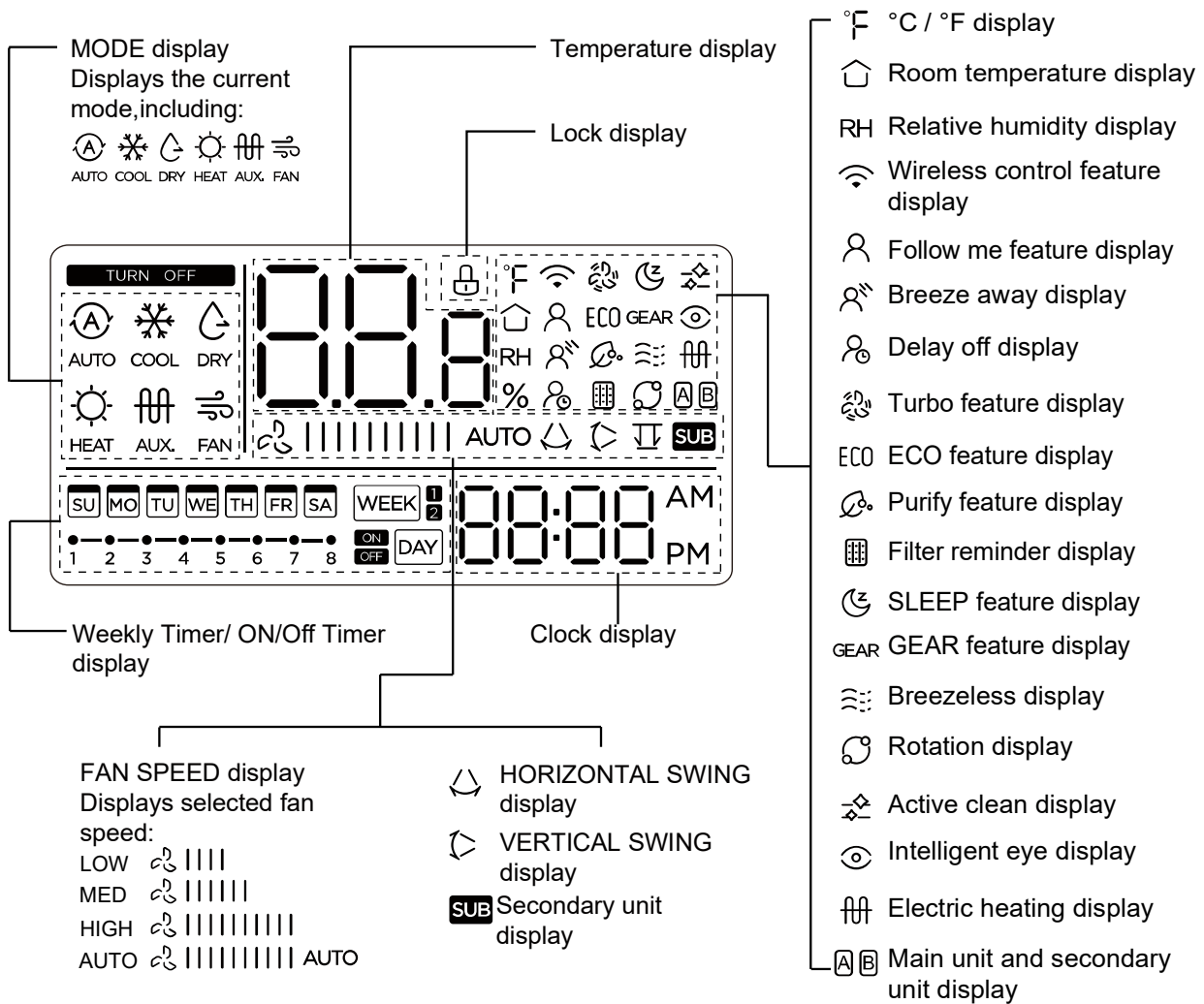

**NOTE**

Please refer to the system's manual for applicable functions.



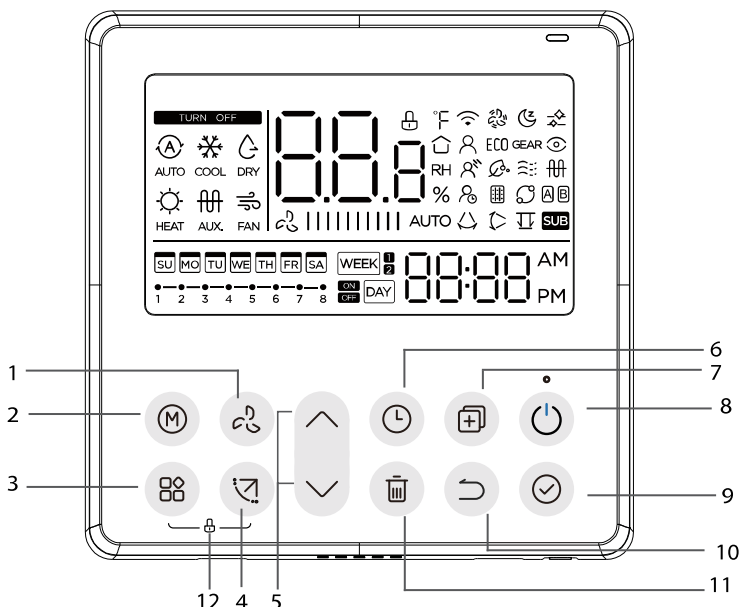













### 07. Wired Controller Buttons



No.	Button
1	FAN SPEED
2	MODE
3	FUNCTION
4	SWING
5	ADJUST
6	TIMER
7	COPY
8	POWER
9	CONFIRM
10	BACK
11	DAY OFF/DELAY
12	CHILD LOCK

## 08. Preparatory Operation

### Set The Current Day And Time.

1		Press the <b>TIMER</b> button for 2 seconds or more. The timer display will flash.
2	 	Press the button  or  to set the day. The selected day will ash. 
3		Press the <b>TIMER</b> button to confirm the day (will also confirm after 10 seconds if no button pressed).
4	 	Press the button  or  to set the current time. Press repeatedly to adjust the current time in 1-minute increments. Press and hold to adjust the current time continuously.  ex. Monday 11:20
5		Press the <b>TIMER</b> button to confirm the day (will also confirm after 10 seconds if no button pressed).
6	 	Time scale selection. Pressing the buttons  and  for 2 seconds will alternate the clock time display between the 12h and 24h scale.

## 09. Operation

### To Start/Stop Operation



Press the Power button.



Applicable on some models

When the heating mode is 10°C / 16°C / 17°C / 20°C , press the down button twice within 1 second to urn on the 8° heating function, and press the Power, Mode, adjust , Fan speed, Timer,and Swing button to cancel the 8° eating function.

### NOTE

For some models, the 8° heating function can only be set by remote control, you can not choose this function by wired controller.

### To Set The Operation Mode



Operation mode setting



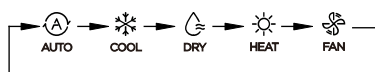



Press this button to select the operation mode:



**Room Temperature Setting**

 Press the button  or  to set the room temperature.

 Indoor Setting Temperature Range :  
10/16/17~30°C or 20~28°C (Model dependent)

 °C and °F scale selection (on some models).  
Press the button  or  for 3 seconds will alternate the temperature display between the °C and °F scale.

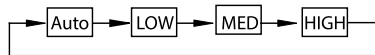

**Fan Speed Setting**

 Press the Fan speed button to set the fan speed. (This button is unavailable under Auto or Dry mode)



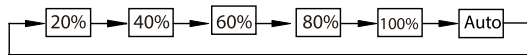



When step less speed regulation is supported, press the fan speed key to cycle through:





 Press the buttons  and  together for 3 seconds to turn on or turn off the keypad tone.

**Child Lock Function**

 Press the buttons  and  for 3 seconds to activate the child lock function and lock all buttons on the wired controller.  
You can't press the buttons to operate or receive the remote control signal after the child lock is activate.  
Press these two buttons again for 3 seconds to deactivate the child lock function.  
When the child lock function is activated, the  mark appears.

**Swing function (For the units with horizontal and vertical swing features only)**

1. Up-Down swing

 Press the **SWING** button to start up-down swing function. The  mark appears. Press it again to stop.

2. Left-Right swing

Press the **SWING** button for 2 seconds to start Left-Right swing function. The  mark appears. Press it for 2 seconds again to stop.

**Swing function (For the units without vertical swing function)**

 • Use Swing button to adjust the Up-down airflow direction and start the auto swing function.

- a. Each time you press this button, the louver swings an angle of 6 degrees. Press this button until the desired direction reaches.
- b. If you press and hold the button for 2 seconds, the auto swing is activated. The  mark appears. Press it again to stop. (some units)

- For the units with four Up-Down louvers, it can be operated individually.



1. Press the **SWING** button to activate the **UP-DOWN** adjusting louver function. The mark will flash. (Not applicable to all the models)

2. Pressing the button or can select the movement of four louvers. Each time you push the button, the louver will be selected in a sequence as:  
(-0 means the four louvers move at the same time.)

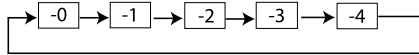

3. And then use **SWING** button to adjust the Up-Down airflow direction of the selected louver.



Press the **FUNC.** button to scroll through operation functions as followings:



[\*]: Model dependent. If the indoor unit has no this function, it will not display. The select function icon will flash, then press the **CONFIRM** button to confirm the setting.

**NOTE**

\* Functions are model dependent, please check the air conditioning manual to see which function is applicable.

**Turbo Function (on some models)**



Under **COOL/HEAT** mode, press the **FUNC.** button to activate the **TURBO** function. Press the button again to deactivate the **TURBO** function. When the **TURBO** function is activated, the mark appears.

**PTC Function (on some models)**



**NOTE**

The electric auxiliary heating function of the AHU model is switched by the **MODE** button, and the **FUNC.** button is a **TURBO** function.

**Follow Me Function Indicator**



Press the **FUNC.** button to select whether the room temperature is detected at the indoor unit or the wired controller.

**Intelligent Eye Display**

- This function is valid in any mode of power-on state.
- When the indoor unit's wired controller is equipped with the **SMART EYE** function, you can activate it by pressing the function key to select the Smart Eye icon and then pressing the OK key. This will turn on the Smart Eye and illuminate the icon. To deactivate the Smart Eye, press the OK key again, and the icon will turn off.
- The **SMART EYE** function will automatically be canceled when you shut down the unit, switch modes, activate the self-cleaning feature, or turn on the 8-degree heating function.



**Filter reset Function** 

When the indoor unit indicates that the filter usage time has been reached, the filter cleaning prompt icon will light up. To reset the filter screen time, press the function key to select the filter cleaning prompt icon, then press the OK key. The filter cleaning reminder icon will turn off.

**Humidity Setting Function**

1. When the indoor unit's wired controller has a dual control function for temperature and humidity, you can adjust the humidity in dehumidification mode. Press the function key to select the RH icon, then press the confirm key to enter humidity control mode. The RH icon will flash. Use the up and down keys to adjust the humidity within a range of OFF to 35%~85%, in 5% increments. If there is no activity for 5 seconds, the controller will exit the humidity adjustment mode.
2. After entering **HUMIDITY** control mode, press the up and down keys to adjust the set temperature. The set temperature will be displayed for 5 seconds, after which the display will revert to showing the set humidity.
3. After switching modes, the system will automatically exit humidity control mode.

**GEAR Function**

1. When the indoor unit's wired controller has the **GEAR** function and is in cooling mode, you can activate it by pressing the function key to select the GEAR icon and then pressing the confirm key to enter **GEAR** control mode. The current GEAR status will be displayed first. You can switch between 50%, 75%, and OFF using the up and down keys within 5 seconds. After 5 seconds, the set temperature will be displayed. You can then adjust the set temperature using the up and down keys.
2. The **GEAR** function will be canceled when you turn off the unit, switch modes, or activate the sleep, ECO, strong, or self-cleaning functions.

When the follow me function  indicator appears, the room temperature is detected by the wired controller.

Press the button again to cancel the **FOLLOW ME** function

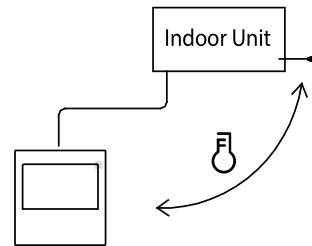

## 10. Time Functions



WEEKLY Timer

Use this timer function to set operating times for each day of the week.



On Timer

Use the timer function to schedule the air conditioner operation. The air conditioner will start operating after the set time has elapsed.



Off Timer

Use this timer function to stop the air conditioner operation. The air conditioner will turn off after the set time has elapsed.



On and Off Timer

Use this timer function to schedule the start and stop of air conditioner operation. The air conditioner will start and stop after the set times have elapsed.

**To Set the On or Off TIMER**

1		Press the <b>TIMER</b> button to select the <b>ON DAY</b> or <b>OFF DAY</b> . 
2		Press the <b>CONFIRM</b> button and the Timer display is flashing.
3		 ex. Off timer set at 18:00 Press the button  or  to set the time. After the time is set, the timer will start or stop automatically.
4		Press the <b>CONFIRM</b> button again to finish the settings.

**To Set the On and Off TIMER**

1		Press the <b>TIMER</b> button to select the <b>ON DAY</b> .
2		Press the <b>CONFIRM</b> button and the Clock display is flashing.
3	 	Press the button  or  to set the time of On timer, and then press the <b>CONFIRM</b> button to confirm the setting.
4		Press the button  or  to set the time of Off Timer,
5		Press the <b>CONFIRM</b> button to finish the setting.

## 11. Weekly Timer 1

1. Weekly Timer Setting



Press the **TIMER** button to select the **WEEK** and then press the **CONFIRM** button to confirm.

2. Day of the Week Setting



Pressing the button or to select the day of the week and then press the **CONFIRM** button to confirm the setting.



3. ON Timer Setting of Timer Setting 1

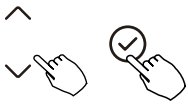

Press the button or to set the time of On timer, and then press the **CONFIRM** button to confirm the setting.



You can save up to 4 timer settings for each day of the week. Setting the WEEKLY TIMER according to your lifestyle can enhance convenience.

4. Off Timer Setting of Timer Setting 1

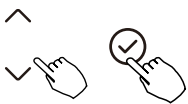

Press the button or to set the timer of Off timer and then press the **CONFIRM** button to confirm the setting.

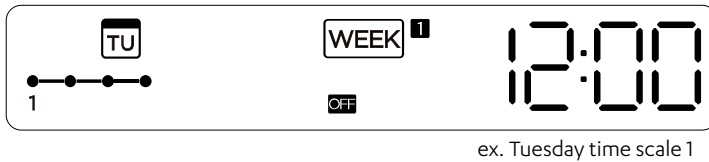

5. Different timer settings can be set by repeating step 3 to 4.

6. Other days in one week can be set by repeating step 2 to 5.

**NOTE**

You can return to the previous step in the weekly timer setting by pressing the Back button. To delete a timer setting, press the Day Off button. If there is no operation for 30 seconds, the current settings will be restored and the weekly timer setting will be withdrawn automatically.

**WEEKLY Timer Operation**

To activate WEEKLY TIMER operation



Press the **TIMER** button while **WEEK** is displayed on the LCD.

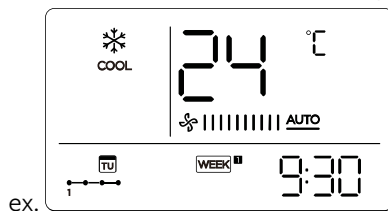

To deactivate WEEKLY TIMER operation



Press the **TIMER** button while **WEEK** is disappeared from the LCD.

To turn off the air conditioner during the weekly timer



- If you press the **POWER** button once quickly, the air conditioner will turn off temporarily. It will turn back on automatically at the time set by the On timer.

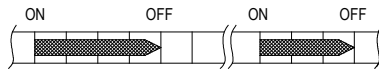

For example, if you press the **POWER** button once quickly at 10:00, the air conditioner will turn off temporarily and then automatically turn on at 14:00.

- When you press the **POWER** button for 2 seconds, the air conditioner will turn off completely and the timing function will be canceled.

**To Set the DAY OFF (for a holiday)**

1		During the weekly timer, press the <b>CONFIRM</b> button.
2		Press the button $\wedge$ or $\vee$ to set select the day in this week.
3		Press the <b>DAY OFF</b> button to set the Day Off. <div style="text-align: center;"> <p>The <b>WE</b> mark is hidden</p> <p>ex. The DAY OFF is set for Wednesday</p> </div>
4		The DAY OFF can be set for other days by repeating the steps 2 and 3.
5		Press the Back button to back to the weekly timer.

To cancel: Follow the same procedures as those for setup.

**NOTE**

The DAY OFF setting is cancelled automatically after the set day has passed.

**DELAY Function**



During the weekly timer, press the **FUNC.** button, select the **DELAY** function and press the **CONFIRM** button, display 0h, 1h, 2h and wait 3 seconds to confirm. When the **DELAY** function is activated, the  $\infty$  mark appears.





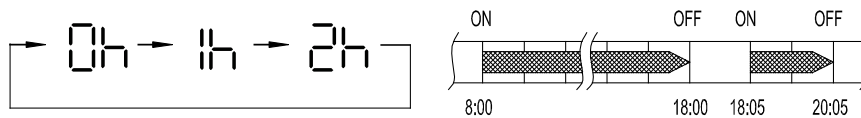









The **DELAY** function can only be enabled in Weekly Timer 1 and Weekly Timer 2.

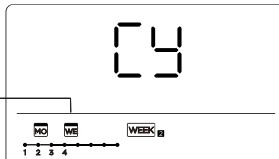

ex. If press select 2h at 18:05, the air conditioner will delay to turn off at 20:05.

**Copy out the setting in one day into the other day (Suitable for Week 1 and Week 2).**

A reservation made once can be copied to another day of the week. The entire reservation for the selected day will be copied. Using the copy mode effectively makes it easier to set up reservations.

1		During the weekly timer, press the <b>CONFIRM</b> button.
2		Press the button  or  to set select the day to copy from.
3		Press the <b>COPY</b> button, the letter <b>CY</b> will be shown on the LCD.
4		Press the button  or  to set select the day to copy to.
5		Press the <b>COPY</b> button to confirm.  <div style="text-align: center;">  <p>The  mark flashes quickly</p> <p>ex. Copy the setting of Monday to Wednesday</p> </div>
6		Other days can be copied by repeating step 4 and 5.
7		Press the <b>CONFIRM</b> button to confirm the settings.
8		Press the <b>BACK</b> button to back to the weekly timer.

## 12. Weekly Timer 2



### 1. Weekly Timer Setting

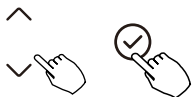

Press the **TIMER** button to select the  and then press confirm.

### 2. Day of the Week Setting



Press the button  or  to select the day of the week and then press the **CONFIRM** button.



3. ON Timer Setting of Timer Setting 1

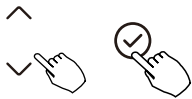

Press the button  $\wedge$  or  $\vee$  to select the setting time. The setting time, mode, temperature and fan speed appear on the LCD. Press **CONFIRM** button to enter the setting time process.

**IMPORTANT:** Up to 8 scheduled events can be set on one day.  
Various events can be scheduled in either **MODE**, **TEMPERATURE** and **FAN** speeds.

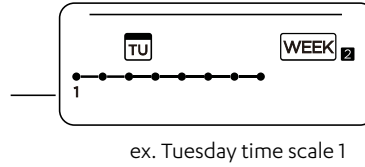

4. Timer Setting



Press the button  $\wedge$  or  $\vee$  to set the time then press the **CONFIRM** button.

5. Operation Mode Setting



Press the button  $\wedge$  or  $\vee$  to set the **OPERATION** mode then press the **CONFIRM** button.

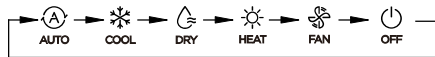

6. Room Temperature Setting



Pressing the button  $\wedge$  or  $\vee$  to set the room temperature, then press the **CONFIRM** button.

**NOTE:** This setting is unavailable in the **FAN** or **OFF** modes.

7. Fan Speed Setting

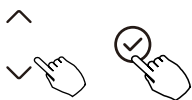

Pressing the button  $\wedge$  or  $\vee$  to set the fan speed then press the **CONFIRM** button.

**NOTE:** This setting is unavailable in the **AUTO**, **DRY** or **OFF** modes.

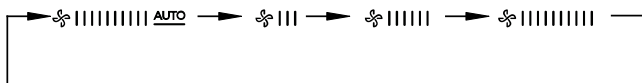

8. Different scheduled events can be set by repeating steps 3 through 7.

9. Additional days, in a one week period, can be set by repeating steps 3 through 8.

**NOTE**

The weekly timer setting can be returned to the previous step by pressing the **BACK** button, which restores the current setting. The controller will not save the weekly timer settings if there is no operation within 30 seconds.

**WEEKLY Timer Operation**

To Start



Press **TIMER** button to select the **WEEK**  $\blacksquare$ , and then the timer starts automatically.

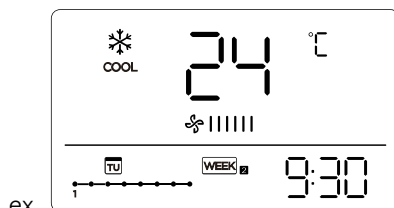

To Cancel



Press the **POWER** button for 2 seconds to cancel the timer mode.  
The **TIMER** mode can also be canceled by changing the **TIMER** mode using Timer.

**To Set the DAY OFF (for a holiday)**

1		After setting the weekly timer, press <b>CONFIRM</b> button.
2		Press the button $\wedge$ or $\vee$ to set select the day in this week.
3		Press the <b>DAY OFF</b> button to create an off day. <div style="text-align: center;"> <p>The <b>WE</b> mark is hidden</p> </div> <p>ex. The Day Off is set for Wednesday</p>
4		Set the DAY OFF for other days by repeating the steps 2 and 3.
5		Press <b>BACK</b> button to revert to the weekly timer.

To cancel, follow the same procedures used for setup.

**NOTE**

The **DAY OFF** setting is cancelled automatically after the set day has passed.

**Copy out the setting in one day into the other day (Refer to Week 1 on page 21)**



**Delete the timer for one day.**

1		During the weekly timer, press <b>CONFIRM</b> button.
2		Press the button $\wedge$ or $\vee$ to select the day of the week and then press <b>CONFIRM</b> button.
3		Press the button $\wedge$ or $\vee$ to select the setting time want to delete. The setting time, mode, temperature and fan speed appear on the LCD. The setting time, mode, temperature and fan speed can be deleted by pressing the DEL (day off). <div style="text-align: center;"> <p>ex. Delete the time scale 1 in Saturday</p> </div>





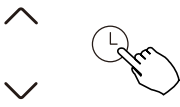

**Set the highest and lowest temperature values**

	<p>When the air conditioning unit is off, enter the <b>QUERY</b> function by pressing the button <math>\wedge</math> or <math>\vee</math> to select <math>\text{EH}</math> or <math>\text{EL}</math>. Press the <b>CONFIRM</b> button into setting state, press the button <math>\wedge</math> or <math>\vee</math> to select the temperature, then press <b>CONFIRM</b> button to complete it.</p>
	<p>The highest setting temperature range : 25~30°C                  The lowest setting temperature range: 17 ~24°C.  <math>\text{EH}</math>: Highest value setting function.  <math>\text{EL}</math>: Minimum value setting function.</p>

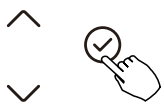
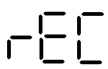
**Remote control function selection of wired controller**

	<p>When the air conditioning unit is off, enter the temperature <b>QUERY</b> function by pressing the button <math>\wedge</math> or <math>\vee</math> to select <math>\text{rEE}</math>. <b>ON</b> or <b>OFF</b> will be displayed in the temperature area to indicate whether it is valid or invalid.                  When the selection is invalid, the wire controller does not process any remote control signals. Press the <b>CONFIRM</b> button to enter the setting state, then use the button <math>\wedge</math> or <math>\vee</math> to select, and press <b>CONFIRM</b> button again to complete it.</p>
	<p>When the selection is invalid, the wired controller does not process any remote control signals. Press the <b>CONFIRM</b> button into setting state, press the button <math>\wedge</math> or <math>\vee</math> to select, then press the <b>CONFIRM</b> button to complete it.</p>

**Restore factory Settings**

	<p>When the air conditioning unit is off, into the <b>QUERY</b> function of temperature, press the button <math>\wedge</math> or <math>\vee</math> to select <math>\text{iniE}</math>, the temperature zone displayed --.                  Press the <b>CONFIRM</b> button into setting state, press the button <math>\wedge</math> or <math>\vee</math> to select to <b>ON</b>, then press <b>CONFIRM</b> button to complete it.</p>
	<p><math>\text{iniE}</math>: Restore factory setting.</p>

After the wired controller resumes the factory parameter settings, the following changes occur:

- The rotating parameter setting is restored to 10 hours (the highest and lowest temperatures are not set).
- The body temperature compensation is reset to uncompensated.
- The **COOL** and **HEAT**/single **COOL** mode is restored to the **COOL** and **HEAT** mode.
- The temperature range is restored to the factory setting.
- The remote receiving function is restored to be effective.
- The address of the two-control first-line controller is restored to the code switch setting.

**Safety Precaution**

- Read the safety precautions carefully before installing the unit.
- Stated below are important safety issues that must be obeyed. Applicable system: IOS, Android. (Suggest: IOS 9.0 and above, Android 6.0 and above.)

**NOTE**

Due to potential special situations, we explicitly state the following: Not all Android and iOS systems are compatible with the app. We will not be responsible for any issues resulting from this incompatibility.

**Wireless Safety Strategy**

Smart kit only support WPA-PSK/WPA2-PSK encryption and none encryption. WPA-PSK/WPA2-PSK encryption is recommended.

**CAUTION**

- Please Check The Service Website For More Information.
- Smart Phone camera needs to be 5 million pixels or above to make sure scan QR code well.
- Due to varying network conditions, request time-outs may occasionally occur. In such cases, it may be necessary to configure the network settings.
- Due to varying network conditions, the control process may sometimes experience time-outs. If this occurs, the display on the board and the app may not be synchronized. Please do not be confused by this discrepancy.

**16. Download and Install the Easyconnect App**

Search Easyconnect on your compatible mobile phone, tap download and then open the app to create a new account.

(Refer to Section 17.03, for new account setup)



**17. Device Configuration**

**17.01. Amazon Alexa**

1. Download Amazon Alexa from google playstore or apple if you haven't done so already. Once logged in, follow below steps



2. Once the Amazon Alexa app has been installed on your device, open up the app. Click on the **More** button which is positioned at the bottom right hand side of the screen. When you click **More** this will take you to a new screen.

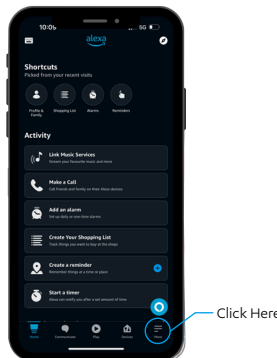

3. On this new screen, click on "Skills & Games" which will take you to a new search screen

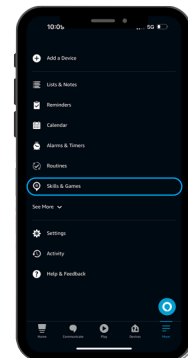

4. Tap on the search tool on the top right hand corner.

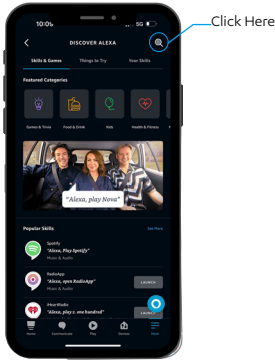

5. Search for "Easyconnect" skill.

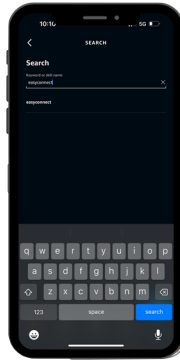

6. Select "Easyconnect" from the results list.

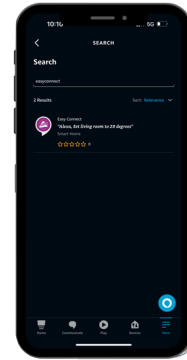

7. Once you have selected EasyConnect from the results list, click on "Enable to Use" button which will take you to the next step.

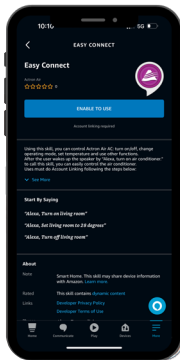

8. A login prompt for Easyconnect will appear, login with your Easyconnect app credentials.

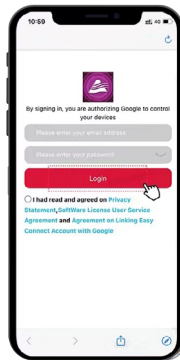

9. Once logged in, the Amazon Alexa App will confirm the successful linking of your account. You can now close this window by clicking on "Done" on the top left hand corner.

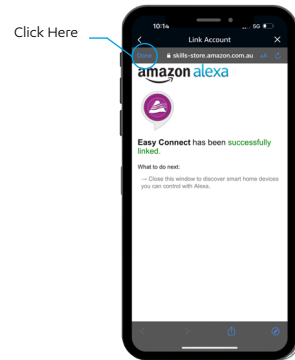

10. Alexa will then start looking for devices to connect with.

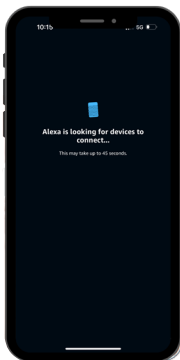

### 17.02. Google Home

1. Download the latest version of Easyconnect App and add the smart device.

2. Download and open Google Home App, tap "Set up device"-

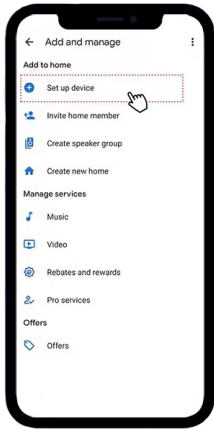

3. Select "Works with Google", and enter to search "easyconnect".

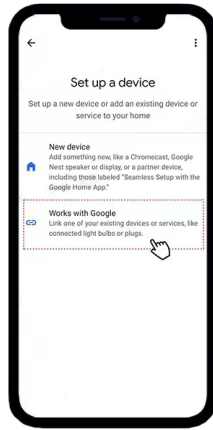

4. Choose "easyconnect" and jump to the authorisation page of Easyconnect App.

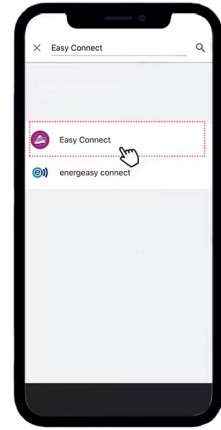

5. After logging in to your Easyconnect account, tap "Agree and Link".

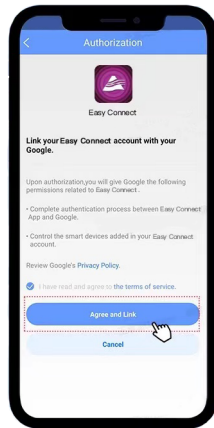

6. You will be redirected to Google Home App and the device will be shown.

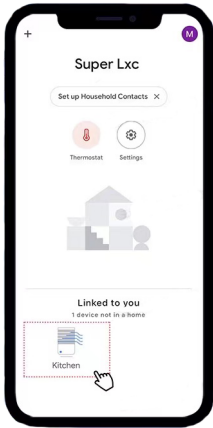

7. Now you can use Google Home voice controller to control your devices.



### 17.03. Smart Device (Easyconnect)

#### Network Configuration

**CAUTION**

- It is necessary to forget any other around network and make sure the Android or IOS device just connect to the Wireless Network you want to configure.
- Make sure the Android or IOS device Wireless Network function works well and can be connected back to your original Wireless Network network automatically.

#### How to enter AP distribution network

Press the **FUNC.** button until the  icon is selected and then press the **CONFIRM** button. **AP** mode is activated if the  icon is blinked.

**NOTES**

- Ensure that the Android or iOS device can be automatically connected to the Wi-Fi network - you can adjust this in your phone settings.
- To configure Easyconnect, a wireless remote controller must be used - a disposable control is supplied in the kit to setup the Wi-Fi.

Configure the network connection. This may be done via Bluetooth, scanning for available devices or by manual selection of the device.

#### Bluetooth Scanning

Ensure that Bluetooth on the mobile device is ON.

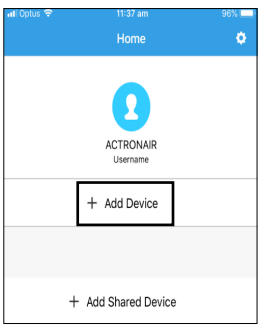
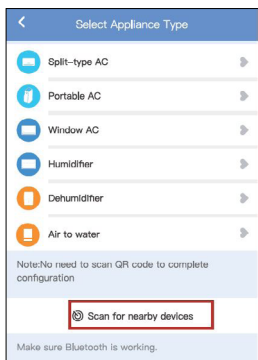
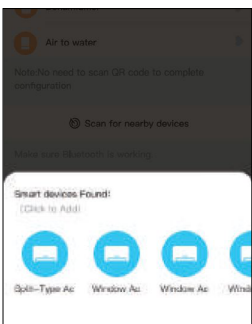
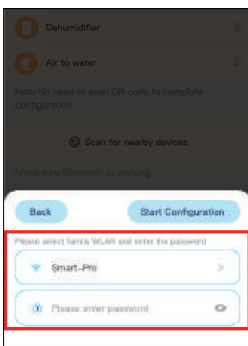
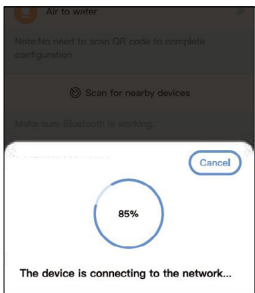
<p>1. Tap on <b>+ Add Device.</b></p> 	<p>2. Power the Air conditioner off from the power supply for 15 seconds, then back on again.</p> <p>3. Within 8 minutes of power being reset, press the LED button on the remote control 7 times (within 10 seconds) - this will initiate access point mode and allow your phone to link with the Easyconnect app setup process.</p>	<p>4. Tap on <b>Scan for nearby devices.</b></p> 
<p>5. Wait smart devices to find, then click to add it.</p>  <p><b>Note:</b> If no device is found, go straight to manual configuration, Google Home Section.</p>	<p>6. Select home Wi-Fi, enter the password.</p> 	<p>7. Wait to connect to the network.</p> 

8. Device successfully detected.  
You can modify the default name.

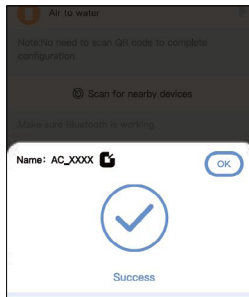

9. You can choose an existing name or customize a new name.

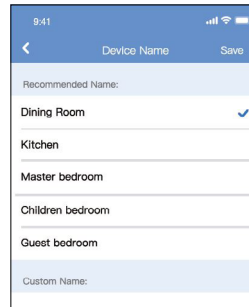

## NOTES

- Make sure your devices are powered on.
- Keep your mobile phone close enough to your device when you are connecting network to your device.
- Connect your mobile phone to the wireless network at home, and make sure you know the password of the Wireless Network.
- Check if your router supports 2.4 GHz Wireless Network band and turn it on. If you are not sure whether the router supports 2.4 GHz band, please contact the router manufacturer.
- The device cannot connect to the Wireless Network that requires authentication, and it usually appears in public area such as hotels, restaurants, etc. Please connect to a Wireless that does not require authentication.
- It is recommended to use a Wireless Network name that only contains letters and numbers. If your Wireless Network name contains special characters, please modify it in the router.
- Turn off the WLAN+ (Android) or WLAN Assistant (iOS) function of your mobile phone when connecting network to your devices.
- In the case that your device connected to Wireless Network before but it needs to reconnect, please click + on app Home page, and add your device again by the device category and model according to the instructions on app.
- If this equipment does cause harmful interference to radio or television reception, which can be determined by turning the equipment off and on, the user is encouraged to try to correct the interference by one or more of the following measures:
  - Reorient or relocate the receiving antenna.
  - Increase the separation between the equipment and receiver.
  - Connect the equipment into an outlet on a circuit different from that to which the receiver is connected.
  - Contact ActronAir Service Department on 1800 119 229.

## CAUTIONS:

Only operate the device in accordance with the instructions supplied.

Changes or modifications to this unit not expressly approved by the party responsible for compliance could void the user's authority to operate the equipment.



[actronair.com.au](http://actronair.com.au)

1300 522 722



©Copyright 2024 Actron Engineering Pty Limited ABN 34 002767240. \*Registered Trade Marks of Actron Engineering Pty Limited. ActronAir is constantly seeking ways to improve the design of its products. Therefore, specifications are subject to change without notice.